



Complementary 20-V (D-S) Low-Threshold MOSFET

| PRODUCT SUMMARY | | | |
|-----------------|---------------------|------------------------------------|--------------------|
| | V _{DS} (V) | r _{DS(on)} (Ω) | I _D (A) |
| N-Channel | 20 | 0.280 at V _{GS} = 4.5 V | 1.28 |
| | | 0.360 at V _{GS} = 2.5 V | 1.13 |
| | | 0.450 at V _{GS} = 1.8 V | 1.0 |
| P-Channel | - 20 | 0.490 at V _{GS} = - 4.5 V | - 1.0 |
| | | 0.750 at V _{GS} = - 2.5 V | - 0.81 |
| | | 1.10 at V _{GS} = - 1.8 V | - 0.67 |

FEATURES

- TrenchFET[®] Power MOSFETS: 1.8 V Rated
- ESD Protected: 2000 V
- Thermally Enhanced SC-70 Package



RoHS*
COMPLIANT

APPLICATIONS

- Load Switching
- PA Switch
- Level Switch

SOT-363
SC-70 (6-LEADS)

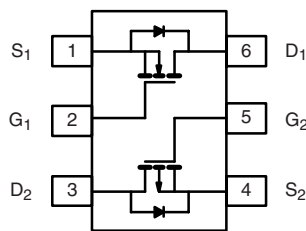

Top View

Marking Code

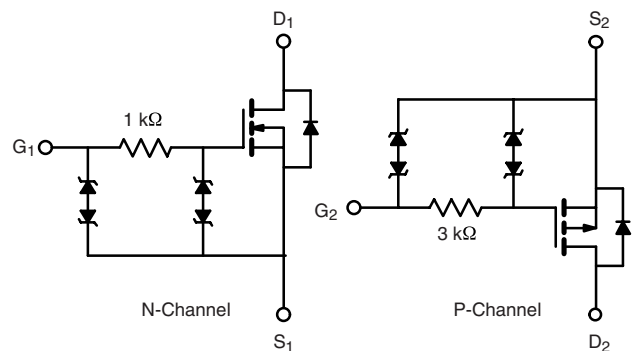
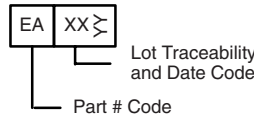

Ordering Information: Si1563EDH-T1
Si1563EDH-T1-E3 (Lead (Pb)-free)

| ABSOLUTE MAXIMUM RATINGS T _A = 25 °C, unless otherwise noted | | | | | | | |
|---|-----------------------------------|------------------------|--------------|-----------|--------------|--------|---|
| Parameter | Symbol | N-Channel | | P-Channel | | Unit | |
| | | 5 s | Steady State | 5 s | Steady State | | |
| Drain-Source Voltage | V _{DS} | 20 | | - 20 | | V | |
| Gate-Source Voltage | V _{GS} | ± 12 | | ± 12 | | | |
| Continuous Drain Current (T _J = 150 °C) | I _D | T _A = 25 °C | 1.28 | 1.13 | - 1.0 | - 0.88 | A |
| | | T _A = 85 °C | 0.92 | 0.81 | - 0.72 | - 0.63 | |
| Pulsed Drain Current | I _{DM} | 4.0 | | - 3.0 | | | |
| Continuous Source Current (Diode Conduction) ^a | I _S | 0.61 | 0.48 | - 0.61 | - 0.48 | | |
| Maximum Power Dissipation ^a | P _D | T _A = 25 °C | 0.74 | 0.57 | 0.30 | 0.57 | W |
| | | T _A = 85 °C | 0.38 | 0.30 | 0.16 | 0.3 | |
| Operating Junction and Storage Temperature Range | T _J , T _{stg} | - 55 to 150 | | | | °C | |

| THERMAL RESISTANCE RATINGS | | | | | |
|--|--------------|-------------------|---------|---------|------|
| Parameter | | Symbol | Typical | Maximum | Unit |
| Maximum Junction-to-Ambient ^a | t ≤ 5 s | R _{thJA} | 130 | 170 | °C/W |
| | Steady State | | 170 | 220 | |
| Maximum Junction-to-Foot (Drain) | Steady State | R _{thJF} | 80 | 100 | |

Notes:

a. Surface Mounted on 1" x 1" FR4 Board.

* Pb containing terminations are not RoHS compliant, exemptions may apply.



| SPECIFICATIONS $T_J = 25\text{ }^\circ\text{C}$, unless otherwise noted | | | | | | | |
|--|--------------|---|------|-------|-------|----------|---------------|
| Parameter | Symbol | Test Conditions | | Min. | Typ. | Max. | Unit |
| Static | | | | | | | |
| Gate Threshold Voltage | $V_{GS(th)}$ | $V_{DS} = V_{GS}, I_D = 100\text{ }\mu\text{A}$ | N-Ch | 0.45 | | | V |
| | | $V_{DS} = V_{GS}, I_D = -100\text{ }\mu\text{A}$ | P-Ch | -0.45 | | | |
| Gate-Body Leakage | I_{GSS} | $V_{DS} = 0\text{ V}, V_{GS} = \pm 4.5\text{ V}$ | N-Ch | | | ± 1 | μA |
| | | | P-Ch | | | ± 1 | |
| | | $V_{DS} = 0\text{ V}, V_{GS} = \pm 12\text{ V}$ | N-Ch | | | ± 10 | mA |
| | | | P-Ch | | | ± 10 | |
| Zero Gate Voltage Drain Current | I_{DSS} | $V_{DS} = 16\text{ V}, V_{GS} = 0\text{ V}$ | N-Ch | | | 1 | μA |
| | | $V_{DS} = -16\text{ V}, V_{GS} = 0\text{ V}$ | P-Ch | | | -1 | |
| | | $V_{DS} = 16\text{ V}, V_{GS} = 0\text{ V}, T_J = 85\text{ }^\circ\text{C}$ | N-Ch | | | 5 | |
| | | $V_{DS} = -16\text{ V}, V_{GS} = 0\text{ V}, T_J = 85\text{ }^\circ\text{C}$ | P-Ch | | | -5 | |
| On-State Drain Current ^a | $I_{D(on)}$ | $V_{DS} \geq 5\text{ V}, V_{GS} = 4.5\text{ V}$ | N-Ch | 2 | | | A |
| | | $V_{DS} \leq -5\text{ V}, V_{GS} = -4.5\text{ V}$ | P-Ch | -2 | | | |
| Drain-Source On-State Resistance ^a | $r_{DS(on)}$ | $V_{GS} = 4.5\text{ V}, I_D = 1.13\text{ A}$ | N-Ch | | 0.220 | 0.280 | Ω |
| | | $V_{GS} = -4.5\text{ V}, I_D = -0.88\text{ A}$ | P-Ch | | 0.400 | 0.490 | |
| | | $V_{GS} = 2.5\text{ V}, I_D = 0.99\text{ A}$ | N-Ch | | 0.281 | 0.360 | |
| | | $V_{GS} = -2.5\text{ V}, I_D = -0.71\text{ A}$ | P-Ch | | 0.610 | 0.750 | |
| | | $V_{GS} = 1.8\text{ V}, I_D = 0.20\text{ A}$ | N-Ch | | 0.344 | 0.450 | |
| | | $V_{GS} = -1.8\text{ V}, I_D = -0.20\text{ A}$ | P-Ch | | 0.850 | 1.10 | |
| Forward Transconductance ^a | g_{fs} | $V_{DS} = 10\text{ V}, I_D = 1.13\text{ A}$ | N-Ch | | 2.6 | | S |
| | | $V_{DS} = -10\text{ V}, I_D = -0.88\text{ A}$ | P-Ch | | 1.5 | | |
| Diode Forward Voltage ^a | V_{SD} | $I_S = 0.48\text{ V}, V_{GS} = 0\text{ V}$ | N-Ch | | 0.8 | 1.2 | V |
| | | $I_S = -0.48\text{ V}, V_{GS} = 0\text{ V}$ | P-Ch | | -0.8 | -1.2 | |
| Dynamic^b | | | | | | | |
| Total Gate Charge | Q_g | N-Channel $V_{DS} = 10\text{ V}, V_{GS} = 4.5\text{ V}, I_D = 1.13\text{ A}$ | N-Ch | | 0.65 | 1.0 | nC |
| | | | P-Ch | | 1.2 | 1.8 | |
| Gate-Source Charge | Q_{gs} | P-Channel $V_{DS} = -10\text{ V}, V_{GS} = -4.5\text{ V}, I_D = -0.88\text{ A}$ | N-Ch | | 0.2 | | |
| | | | P-Ch | | 0.3 | | |
| Gate-Drain Charge | Q_{gd} | | N-Ch | | 0.23 | | |
| | | | P-Ch | | 0.3 | | |
| Turn-On Delay Time | $t_{d(on)}$ | N-Channel $V_{DD} = 10\text{ V}, R_L = 20\text{ }\Omega$ $I_D \cong 0.5\text{ A}, V_{GEN} = 4.5\text{ V}, R_g = 6\text{ }\Omega$ | N-Ch | | 45 | 70 | ns |
| | | | P-Ch | | 150 | 230 | |
| Rise Time | t_r | P-Channel $V_{DD} = -10\text{ V}, R_L = 20\text{ }\Omega$ $I_D \cong -0.5\text{ A}, V_{GEN} = -4.5\text{ V}, R_g = 6\text{ }\Omega$ | N-Ch | | 85 | 130 | |
| | | | P-Ch | | 480 | 720 | |
| Turn-Off Delay Time | $t_{d(off)}$ | | N-Ch | | 350 | 530 | |
| | | | P-Ch | | 840 | 1200 | |
| Fall Time | t_f | | N-Ch | | 210 | 320 | |
| | | | P-Ch | | 850 | 1200 | |

Notes:

- a. Pulse test; pulse width $\leq 300\text{ }\mu\text{s}$, duty cycle $\leq 2\%$.
b. Guaranteed by design, not subject to production testing.

Stresses beyond those listed under "Absolute Maximum Ratings" may cause permanent damage to the device. These are stress ratings only, and functional operation of the device at these or any other conditions beyond those indicated in the operational sections of the specifications is not implied. Exposure to absolute maximum rating conditions for extended periods may affect device reliability.



N-CHANNEL TYPICAL CHARACTERISTICS 25 °C, unless otherwise noted

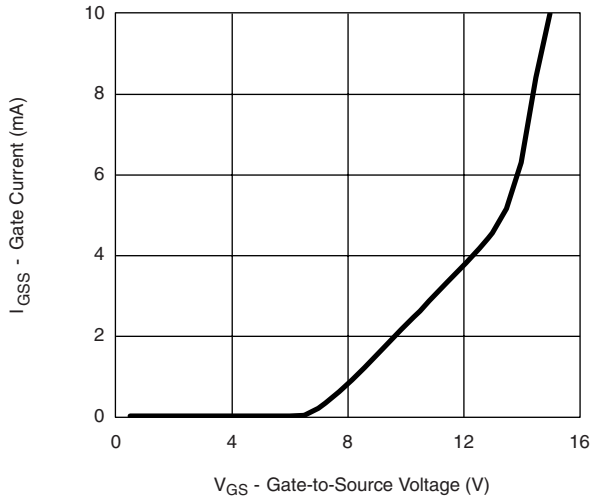

Gate-Current vs. Gate-Source Voltage

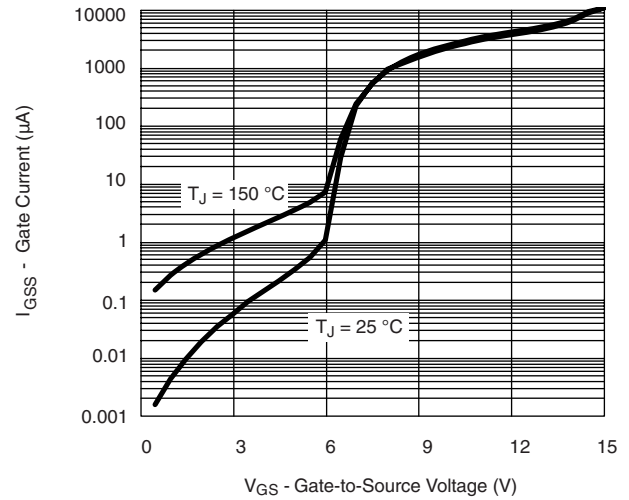

Gate-Current vs. Gate-Source Voltage

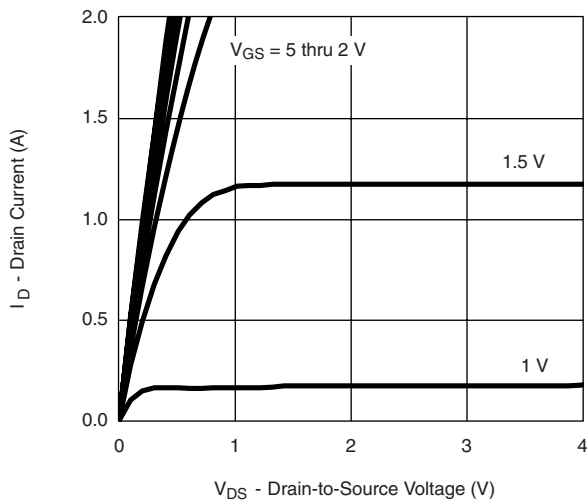

Output Characteristics

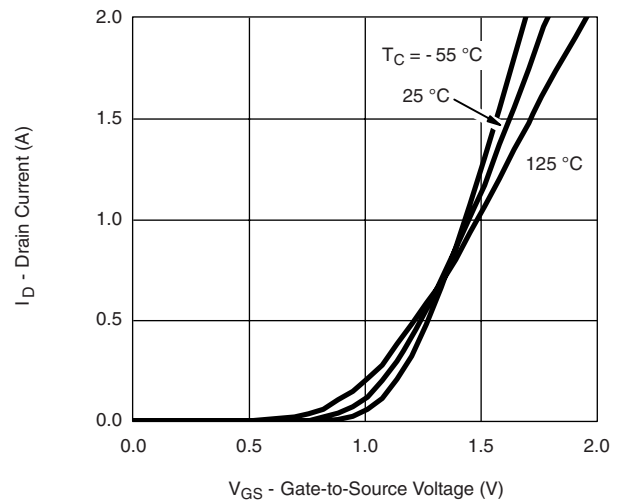

Transfer Characteristics

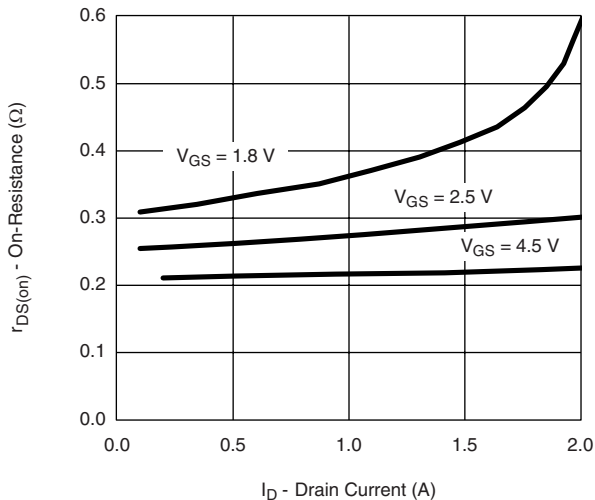

On-Resistance vs. Drain Current

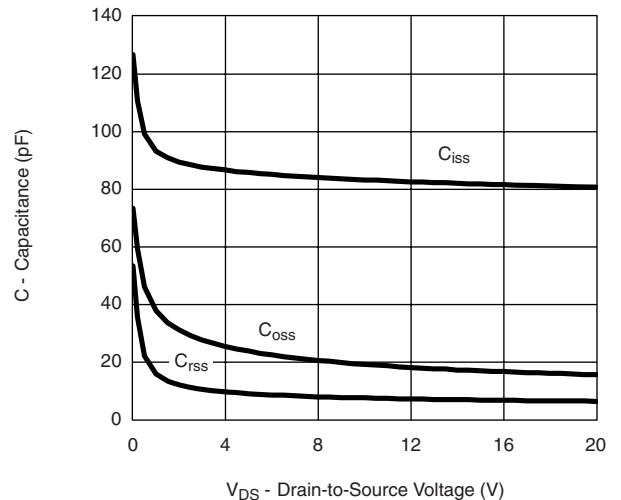

Capacitance



N-CHANNEL TYPICAL CHARACTERISTICS 25 °C, unless otherwise noted

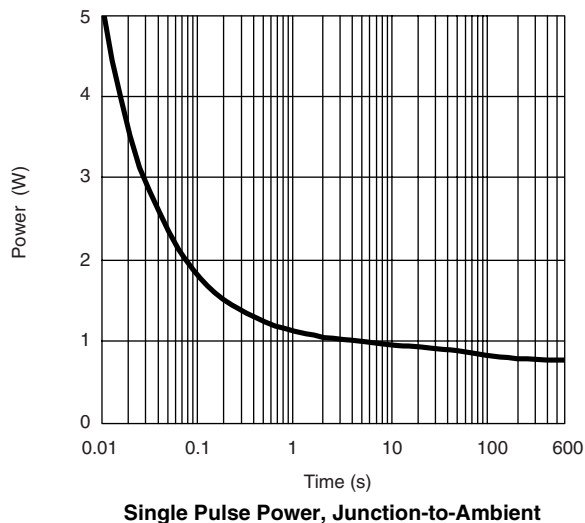
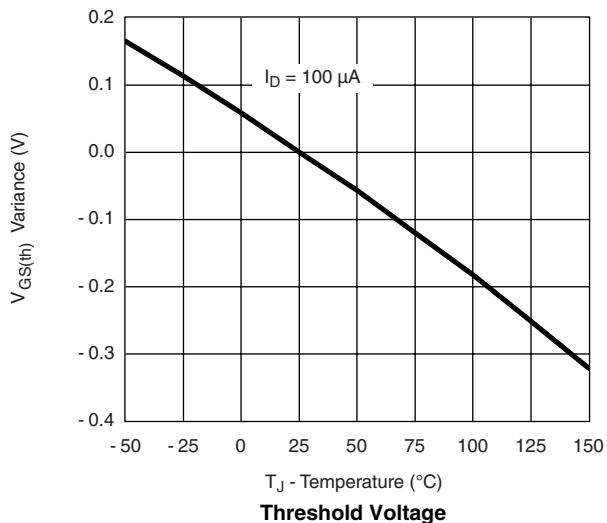
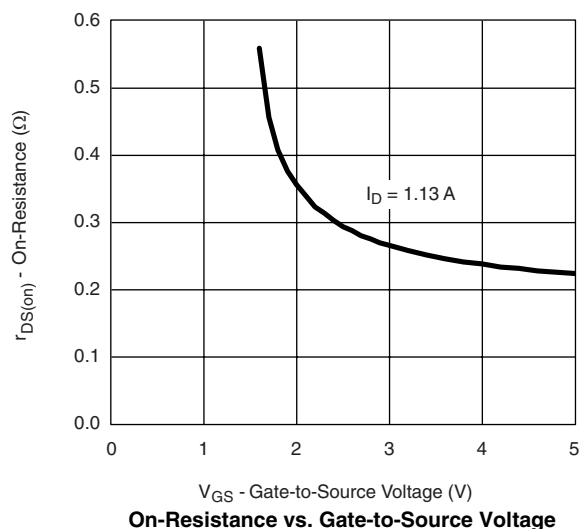
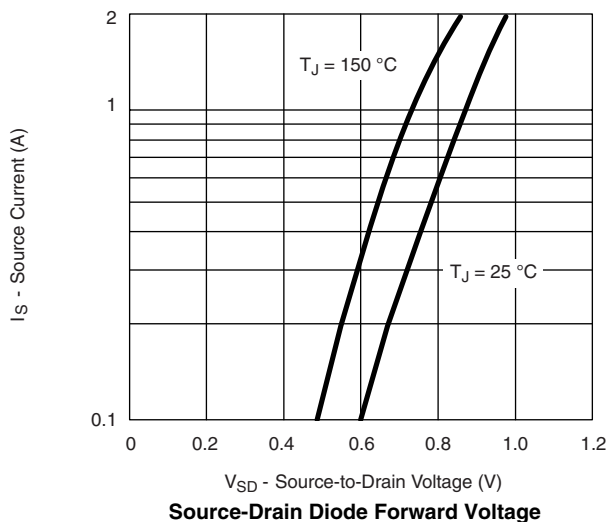
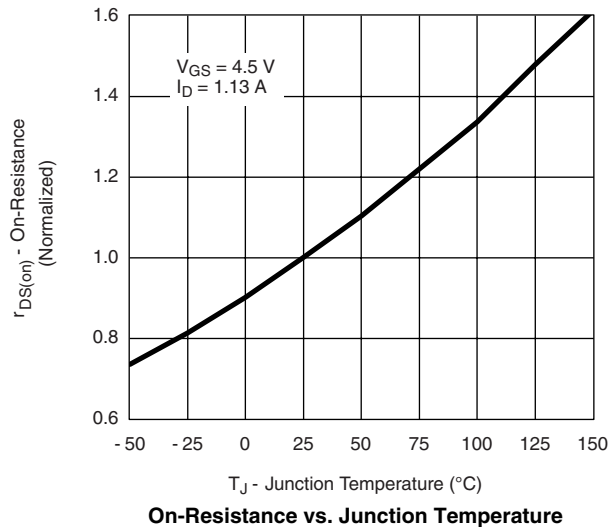
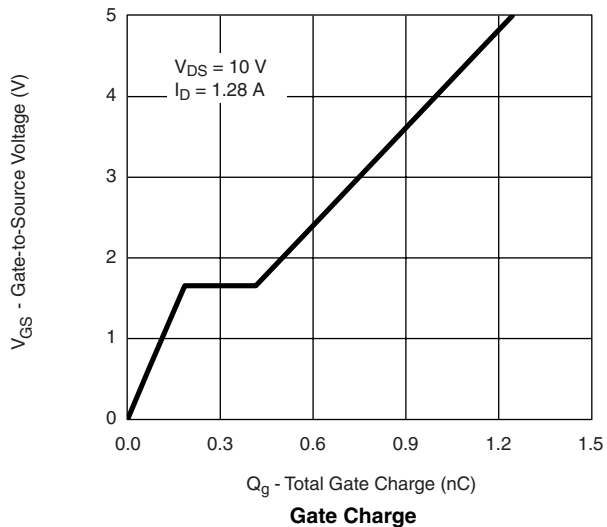



N-CHANNEL TYPICAL CHARACTERISTICS 25 °C, unless otherwise noted

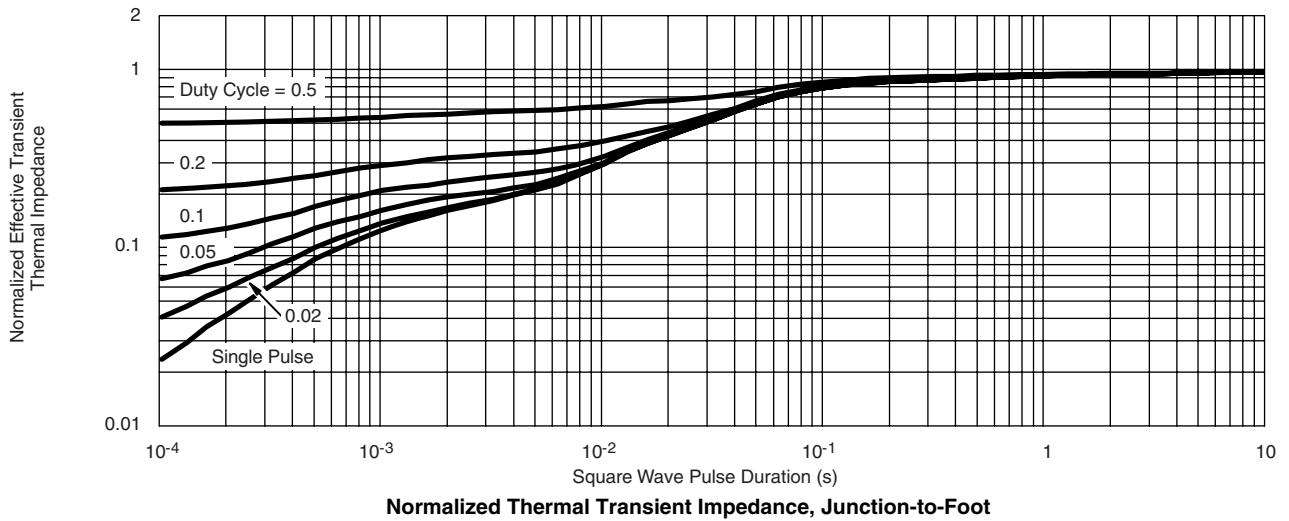
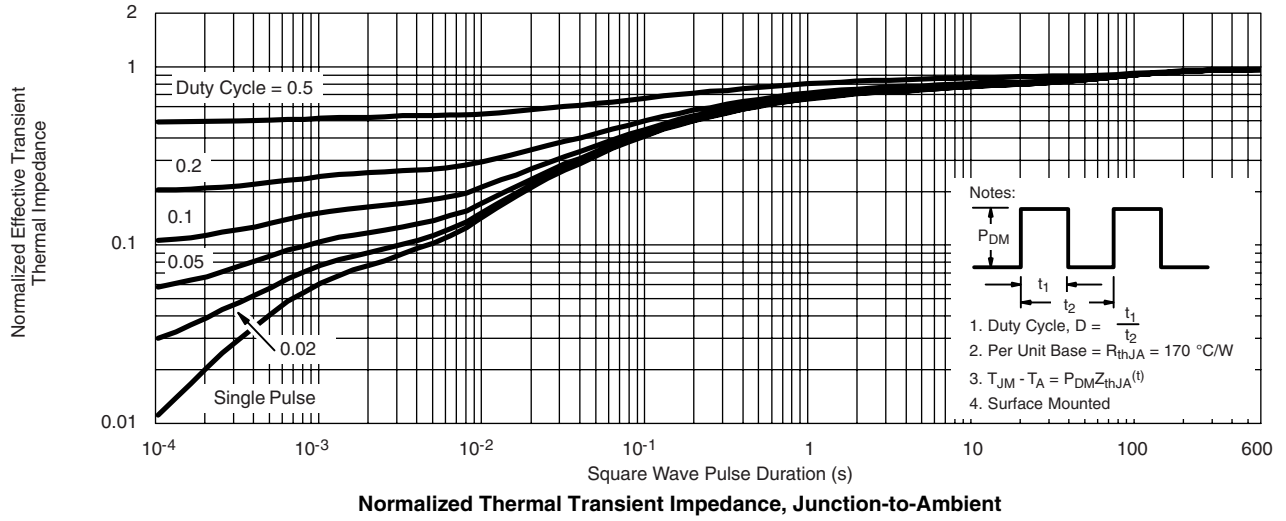



P-CHANNEL TYPICAL CHARACTERISTICS 25 °C, unless otherwise noted

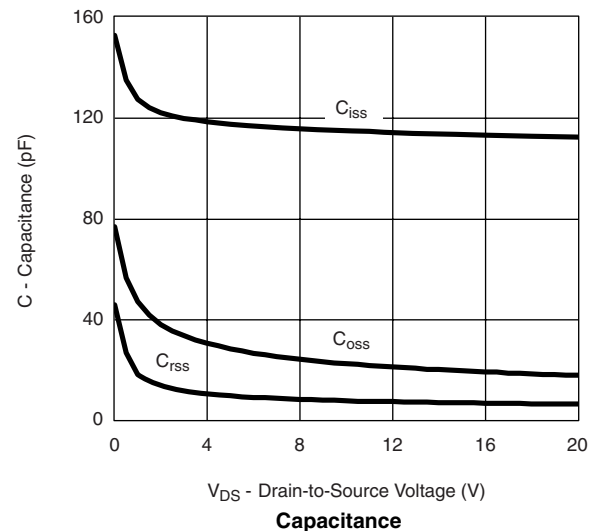
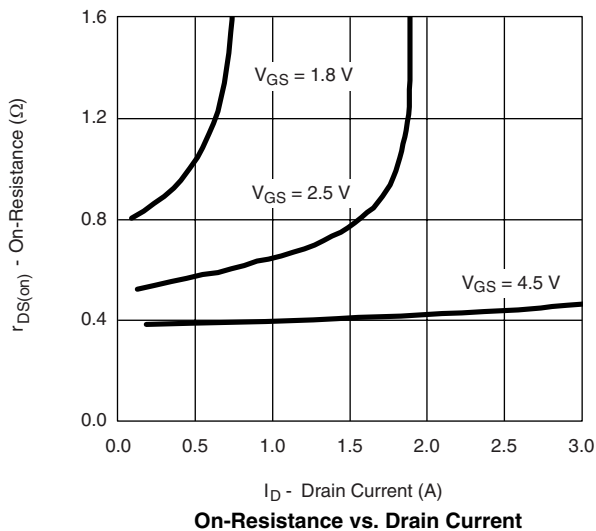
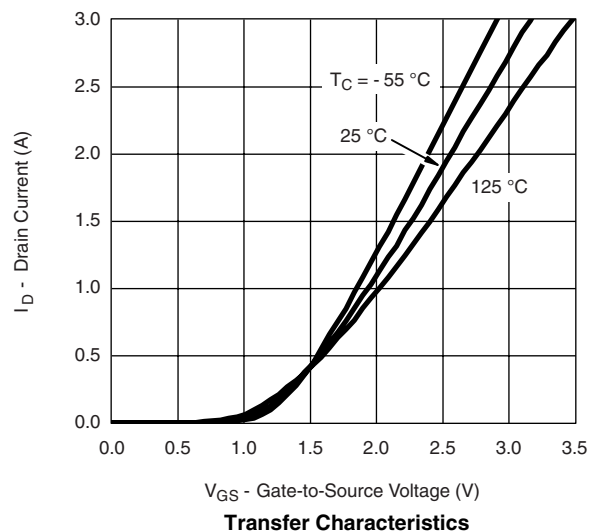
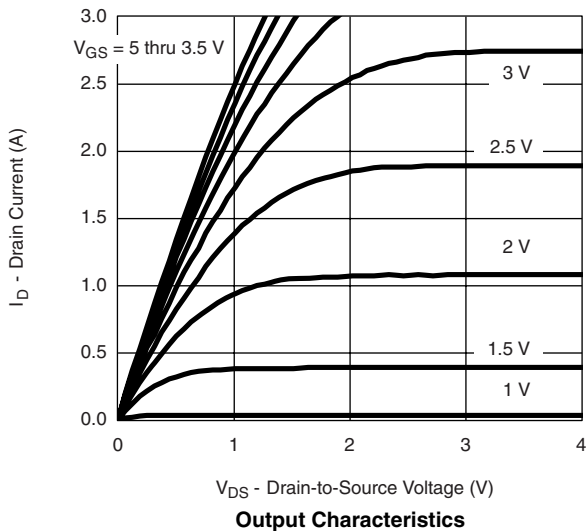
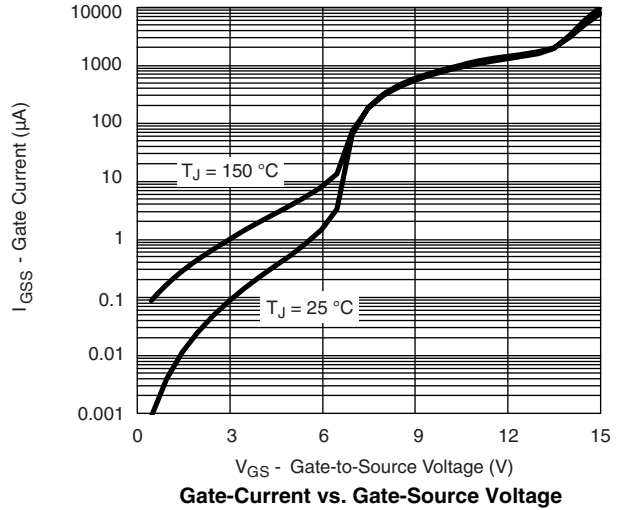
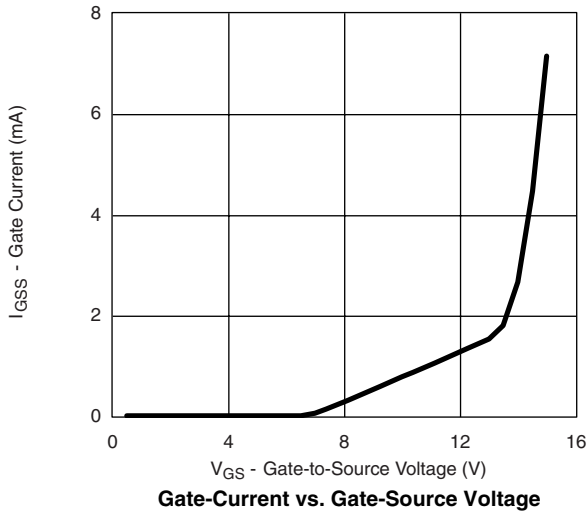



P-CHANNEL TYPICAL CHARACTERISTICS 25 °C, unless otherwise noted

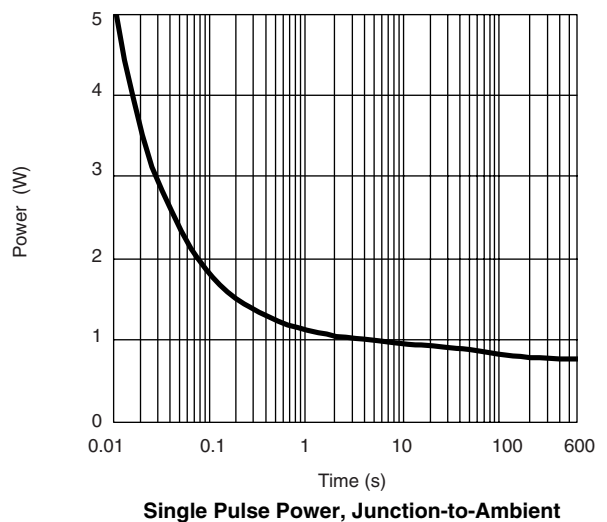
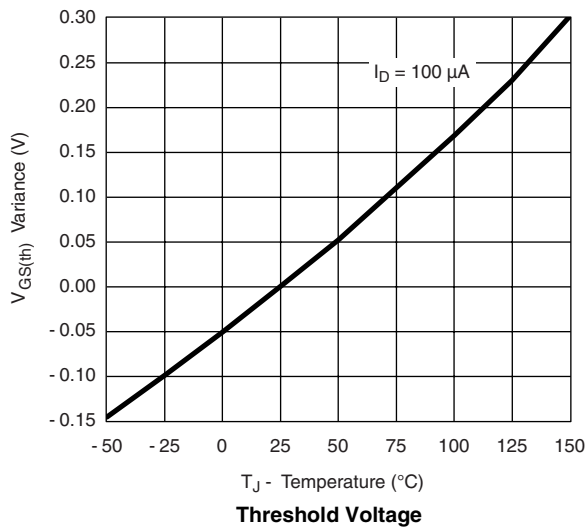
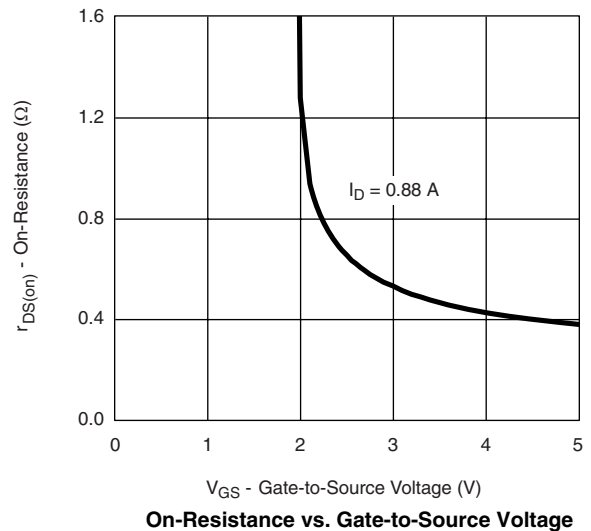
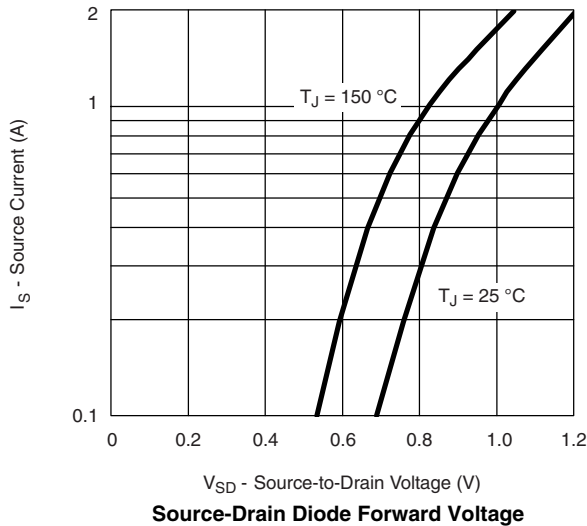
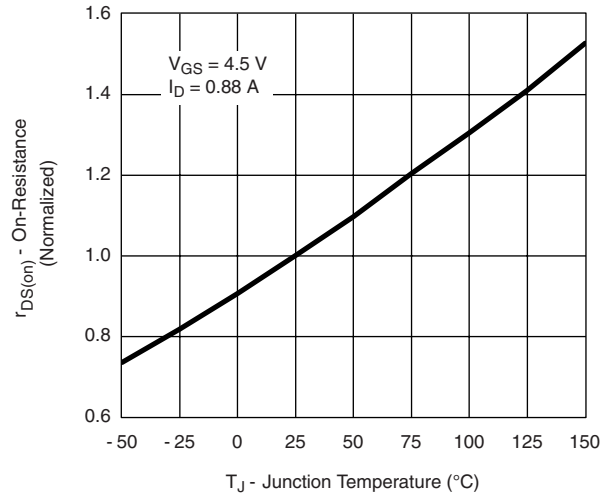
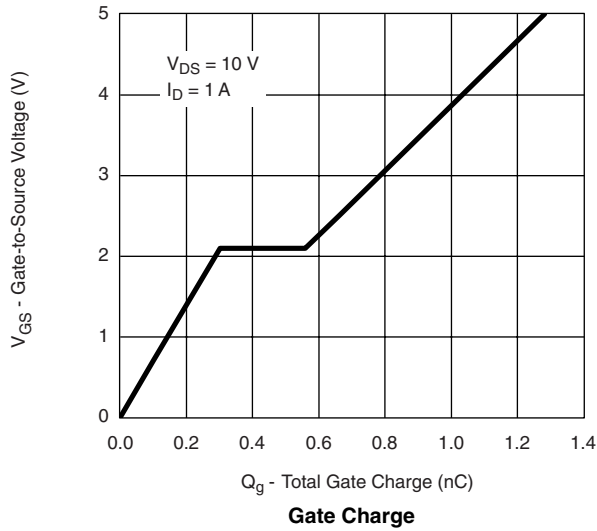



P-CHANNEL TYPICAL CHARACTERISTICS 25 °C, unless otherwise noted

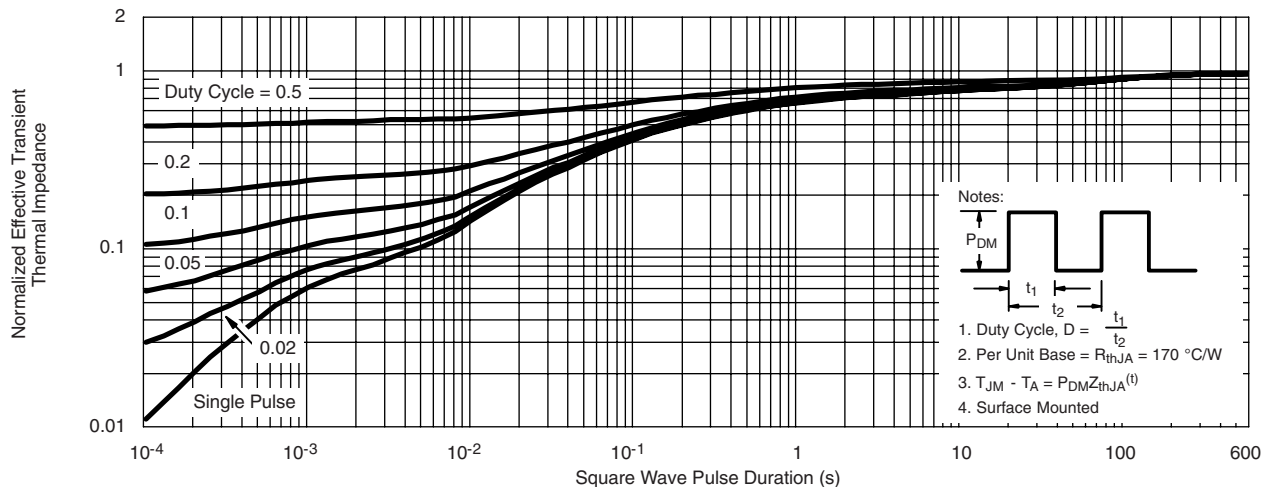

Normalized Thermal Transient Impedance, Junction-to-Ambient

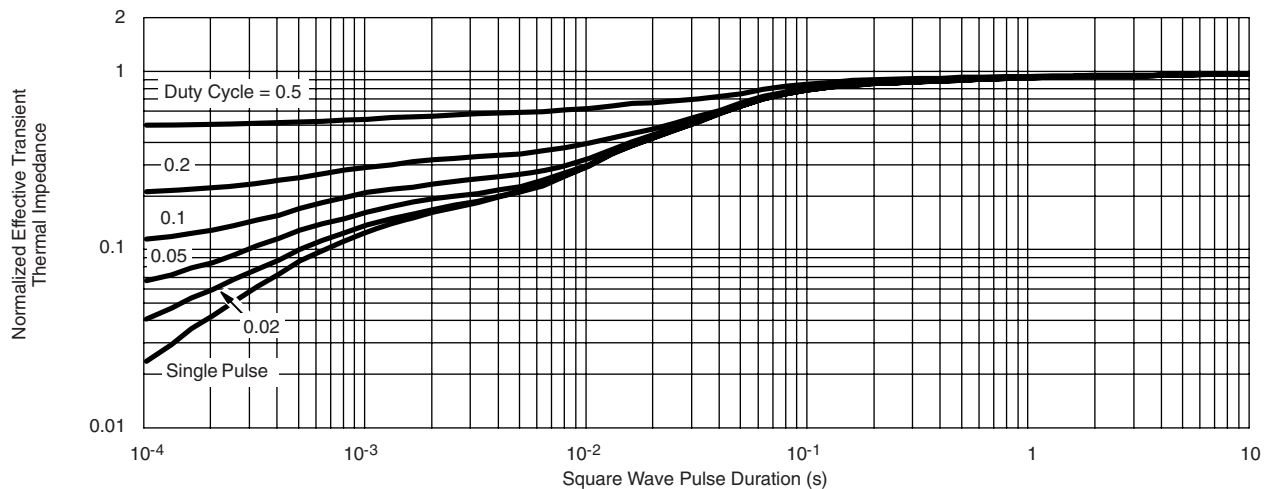

Normalized Thermal Transient Impedance, Junction-to-Foot

Vishay Siliconix maintains worldwide manufacturing capability. Products may be manufactured at one of several qualified locations. Reliability data for Silicon Technology and Package Reliability represent a composite of all qualified locations. For related documents such as package/tape drawings, part marking, and reliability data, see <http://www.vishay.com/ppg?71416>.



Disclaimer

All product specifications and data are subject to change without notice.

Vishay Intertechnology, Inc., its affiliates, agents, and employees, and all persons acting on its or their behalf (collectively, "Vishay"), disclaim any and all liability for any errors, inaccuracies or incompleteness contained herein or in any other disclosure relating to any product.

Vishay disclaims any and all liability arising out of the use or application of any product described herein or of any information provided herein to the maximum extent permitted by law. The product specifications do not expand or otherwise modify Vishay's terms and conditions of purchase, including but not limited to the warranty expressed therein, which apply to these products.

No license, express or implied, by estoppel or otherwise, to any intellectual property rights is granted by this document or by any conduct of Vishay.

The products shown herein are not designed for use in medical, life-saving, or life-sustaining applications unless otherwise expressly indicated. Customers using or selling Vishay products not expressly indicated for use in such applications do so entirely at their own risk and agree to fully indemnify Vishay for any damages arising or resulting from such use or sale. Please contact authorized Vishay personnel to obtain written terms and conditions regarding products designed for such applications.

Product names and markings noted herein may be trademarks of their respective owners.